

# Schletter Solar Mounting Systems

## *System Overview* *Roof Mount*



## Schletter Products

All Schletter solar mounting systems are specifically designed to meet or exceed applicable International Building Code (IBC) and ASCE standards. Most of the roof mount systems listed within this brochure meet UL Standards.

Information contained within this document is subject to change.

# CONTENTS

<b>General Information</b>	<b>4</b>
System Design	5
<b>Standard Flush Mount</b>	<b>6</b>
Roof Hooks	6
Standoff	6
Sheet Metal Attachments	7
Mounting Options	8
<b>Components</b>	<b>10</b>
Module Clamps, Laminate and Framed	10
Laminate Safety Hooks	10
SolTub, Ballast Tray	10
Rails and Cross Beams	11
<b>Flat Roof Systems</b>	<b>12</b>
<b>Facade &amp; Awnings</b>	<b>14</b>
<b>Accessories</b>	<b>14</b>

## General Information

Schletter® solar photovoltaic (PV) mounting systems are designed as modular systems using quality materials including aluminum and stainless steel. Our easy-to-use systems allows for connections to most modules and in nearly any solar mounting situation or configuration.

### Setup for Success

We equip our customers with tools for success including:

- Installation manuals
- Calculation programs
- System drawings
- Structural analysis documentation

These tools combined with Schletter's commitment to a successful partnership with our customer' ensures the highest quality installation, product safety, and cost savings.

### State-of-the-Art Production Facilities

Schletter is proud of its state-of-the-art production facilities that allow us to provide innovative and cost-effective manufacturing of both standard and custom components and systems.

Standards Schletter adheres to include:

- Welding procedures are certified according to DIN 18.800 (welding standard for supporting structures)
- Quality control is carried out according to DIN ISO 9001:2008 and all our aluminum system components are backed by a 20 year warranty

For more information about all Schletter offerings, please visit our website and review our brochures at [www.schletter.us](http://www.schletter.us). Schletter Inc. proudly manufacturers its products in Shelby, North Carolina.

### Please Note:

- In this brochure, each system component is briefly described. Further information about the single components can be found in the Components Overview and the detailed spec-sheets on the single components available on our websites. For U.S. documentation and information visit [www.schletter.us](http://www.schletter.us) or for Canadian specific information at [www.schletter.ca](http://www.schletter.ca).
- Further information on the different types of mounting systems is summarized in product sheets.

### Important information

In this brochure, the system components are described briefly. Further information about the individual components can be found in the component overview.

Further information about the different systems are summarized in product sheets and application instructions.

➔ This sign refers to additional product documentation online.

➔ This sign refers to further relevant documents.

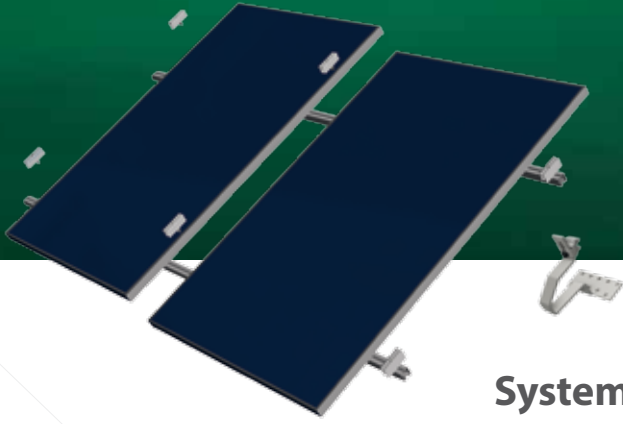

## System Design

Regardless of the solar (PV) mounting systems, each system follows similar principals to connect to a roof or the ground. In general, a PV roof-mounted system consists of rails carrying row(s) of modules and a connection to the roof an/or substructure. This connection is accomplished by means of fastening elements appropriate for the roofing material. Schletter offers ETL Listed module clamps to electrically bond the system once installed, in addition to a variety of accessories for most applications.

The vast majority of modules are mounted vertically or horizontally. While there are various kinds of system configurations available, always check that configurations are structurally sound and 100% code compliant, meeting local building code.



The system is mounted parallel to the roof.

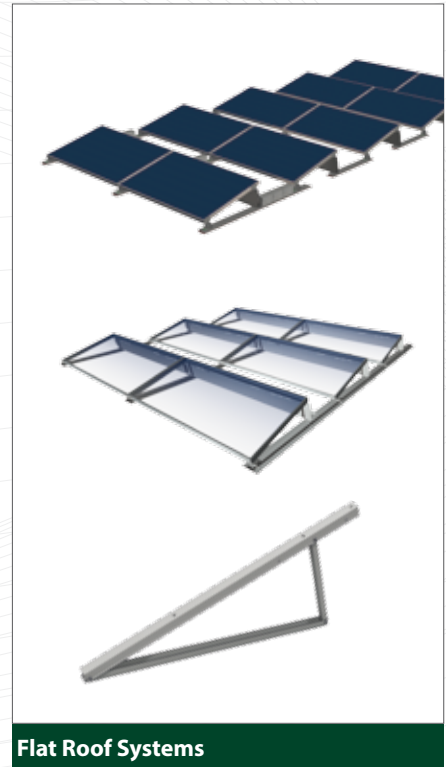

On flat roof, the inclination angle of modules can be changed to increase solar yields.

# FLUSH MOUNT



## Schletter Standard Flush Mount

The easiest option for a flush-mounted roof top system (also called roof parallel) is made up of the following components:

- Roof attachment (also referred to as fastening elements)
- Module carrying rails — connect directly to the roof attachment
- Module clamps and hardware needed to attach clamps

Schletter provides Powersite, an ease-to-use online design and ordering tool which includes the flush mount design application (Powerhouse). **Please visit [www.schletter.us](http://www.schletter.us) to design a Standard Flush Mount** system or contact your Schletter Sales Representative for assistance.

## Flush Mount Roof Connections

A wide range of roof hooks, standoff's, and a variety of other types of fastening elements enable a safe, secure connection of the solar mounting system to almost any roof construction. Structural design tools indicate the number of fastening elements required for installation in the roof's corner and edge zones (array perimeter) as well as define the possible rail span under specific wind and snow conditions. Please visit [www.schletter.us](http://www.schletter.us) and select the Flush Mount Design Tool to begin your layout. For larger projects, please contact a Schletter team member for design and ordering assistance.

For more details on all fastening elements, see the Components Catalog.

➔ Component Overview: Roof Attachments

### Roof Hooks

Roof hooks are available for asphalt shingle, most tile, and slate roofing material. The Rapid<sup>2+</sup> design feature allows for quick connections to Schletter rails, saving valuable installation time. The economically priced welded hook designs are available in different thicknesses to accommodate for varying snow and wind loads. All hooks are made of high-grade stainless steel grade 304.

In addition to Schletter manufactured roof hooks, Schletter distributes Quick Mount PV<sup>®</sup> kits specifically designed to quickly connect to Schletter rails, as well as EcoFasten<sup>®</sup>. Both Quick Mount PV and EcoFasten kits include flashing and hardware required for installation and are included in Schletter online design tool.

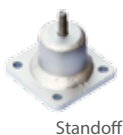
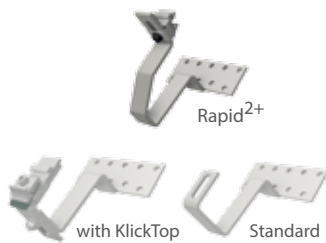

### Standoff

Standoff are a penetrating alternative attachment method on various types of roofs. They can be used on asphalt shingle, concrete tile and on flat roof applications where a tilt up system is being installed. As with any roof-penetrating system, it is suggests that standoffs are sealed for watertightness by a licensed roofer.

## Sheet Metal Roof Attachments

With the variety of metal roofing material, it is necessary to have a selection of fastening elements to choose. Schletter offers products for corrugated sheet metal, trapezoidal, and standing seam connections. Though Schletter offers components for many sheet metal roofing materials, and offers products to help seal penetrations, responsibility for installation and sealing lies with the installer for all roof penetrating products.

### Corrugated Sheet Metal Roof Attachments

Since there are many different types of corrugated sheet metal roofs, different attachment methods are needed for optimal connections. Penetrations should be made on the corrugations rather than the valleys of the sheet metal to minimize the possibility of leaks due to roof penetrations.

#### Single VarioFix-V™

The VarioFix-V is an off-the-shelf fastening device for trapezoidal shaped corrugated sheet metal roofs, similar to the Fix2000 mentioned below. Single VarioFix-V penetrates directly into the corrugation and NOT into the wooden or steel substructure of the building. A minimum of 24 gauge roof metal is required. The VarioFix-V has an EPDM insert for additional sealing and is delivered with sealing washers.

➔ [VarioFix-V Product Sheet](#)

#### Fix2000™ and the Fix2000™ KlickTop™

The Fix2000 clamp is custom manufactured for the individual trapezoidal sheet metal form, and is mounted with four self-drilling, self-sealing screws. Penetrating directly into the corrugation and NOT into the wooden or steel substructure of the building. A minimum of 24 gauge roof metal is required for this option. An optional EPDM insert is available for additional sealing and is delivered with sealing washers. The alternative to the Fix2000 standard mount includes the KlickTop connector for ease of installation.

➔ [Fix2000/Fix2000 KlickTop Product Sheet](#)

#### FixT™

The FixT is a universal connection device for trapezoidal sheet metal roofs. In this standard design, several pre-punched holes are available to meet the needs of various spans. With the FixT, the load is transferred to the substructure using self-tapping screws for steel purlins, or with lag screws for wood purlins. Special connection components made of aluminum ensure a secure connection to the majority of roof decking.

### Standing Seam Clamps

On sheet metal roofs, with standing seams, standing seam clamps are used for the roof connection and to carry the rail. Schletter offers the 503 Standing Seam Clamp and a range of S-5!® clamps which securely pinch the seam and do not interfere or damage the integrity of the seam. The structural integrity of the roof cladding must be taken into account (e.g. adequately fastened to the substructure to withstand the wind loads).

A standing seam clamp application on titanium-zinc sheet metal roofs is not recommended, as these roofs are very brittle at subzero temperatures, which easily leads to crack formation. We offer clamps for the more popular sheet metal roofing types.

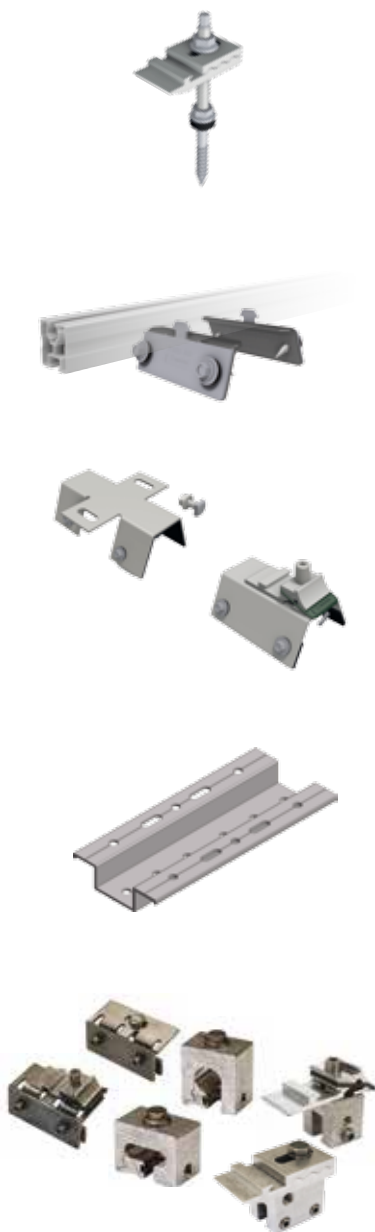

# FLUSH MOUNT

## Mounting Options



Pitched roofs require different types of installation requirements depending on site conditions. Modules will be mounted in landscape or portrait and may require more than one layer of rail. Such cross rail installations are offered under Schletter's GridNorm system for use when the substructure does not offer suitable connection points.

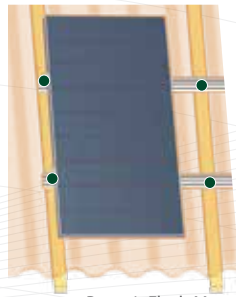

Portrait Flush Mount

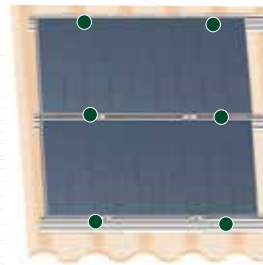

Landscape Flush Mount



GridNorm Cross Rails

### Single Layered Flush Mount System

In the majority of flush mount installations, it is recommended to install modules in portrait (vertical) position.

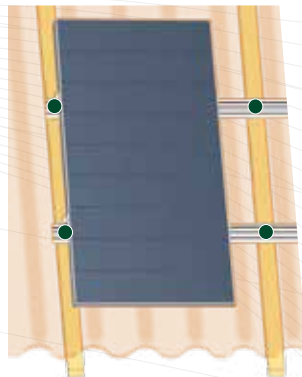

Vertical to the Substructure — Rafter

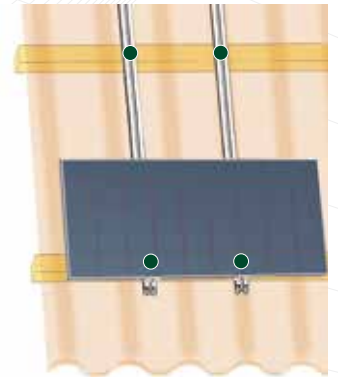

Vertical to the Substructure — Purlin



### Cross connector Rapid / KlickTop



- ➔ GridNorm product sheet
- ➔ Component overview

### GridNorm™ System: Layer Design with Cross Rails

GridNorm is the solution when a racking system needs to be configured as a layer system. A layer system adds an additional load distributing rail to the Standard Flush Mount (see following images). It is needed when the roof substructure does not meet with the span requirements of the roof attachments, or when a special module orientation is needed in relation to the direction the trusses run to the module carrying rails. A load distributing rail should always cross the load carrying trusses of the roof in a 90° angle. If the cross rails cannot achieve that directly due to the module orientation, a second rail layer is needed. Rails in a layer system are connected using the KlickTop™ Cross Connector.

➔ [GridNorm Product Sheet](#)

### Cross Rail

Cross rail mounting is highly recommended if the substructure does not feature suitable mounting locations.

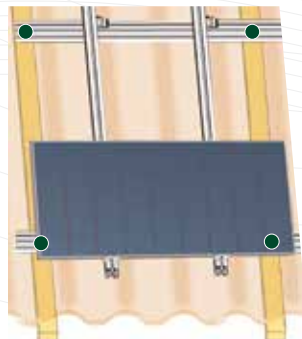

Cross Rail 1 — Rafter

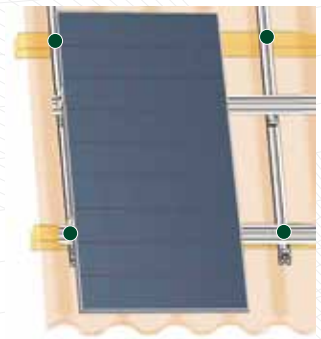

Cross Rail 1 — Purlin



Cross Rail 2 — Rafter

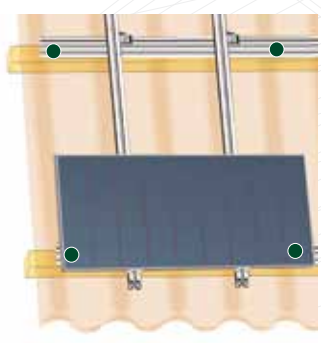

Cross Rail 2 — Purlin

### Linear Support

Designed specifically for horizontal (landscape) mounting.

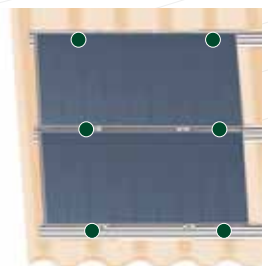

# COMPONENTS

## Module Clamping and Components

Schletter mostly uses what is referred to as “top down” clamps. The clamps hold the modules to the rack by applying pressure to the module frame in a material-friendly manner. At the same time, the clamps distribute the loads evenly and avoid tensions on the module glass and the module cells. Schletter carries mid- and end-clamps for nearly all sizes of module frames. For detailed clamping and component information, please see:

➔ [Component Overview: Roof Attachments](#)



### Eco Series™ Laminate Clamps

The Eco Series is used for frameless solar modules. There are different clamps for different module thicknesses. Please note that safety hooks are required for portrait (vertical) installation of modules on tilted systems. On frameless modules there cannot be too much pressure applied to hold the module to the rack. Otherwise the glass modules would break.



### NEW! Rapid5K™ Clamps

Based on the time-testing Rapid2+ module clamp, the Rapid5K is Schletter’s latest product addition offering a more compact design and robust performance than its predecessor. Considered a top-down module clamp, the Rapid5K quickly clamps the modules to cross beams by using pressure to hold the module down, eliminating the use of cumbersome nuts and bolts. Meeting the latest UL 2703 requirements and Certification to ULC/ORD Standard C1703 the Rapid5K module clamp is used in conjunction with leading industry modules and Schletter systems. See system installation manuals for more details.



### Laminate Safety Hooks

The laminate safety hook prevents gravity from pulling the module out of place. Safety hooks available in 0.26” / 6.8 mm and 0.31” / 8 mm sizes.

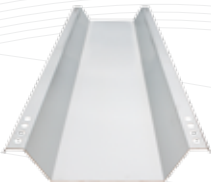

### SolTub™

Often a PV system can be held on a roof or on the ground by being ballasted using concrete blocks or pavers, such as with the Windsafe™ System. Commonly this method is used on tilted systems on flat roof surfaces. There are several options for ballast holding devices that can be adapted to the rack design. SolTub aluminum trays simplify installation and reduce cost. Depending on wind loads, the height of building, tilt of the racking system, and the location of the racking system on the roof, different ballast requirements in terms of weight are needed. There are several sizes and dimensions of SolTubs offered in the Schletter line:

	Top width	Bottom width	Height
SolTub #2	421 mm / 16.6 in	287 mm / 11.3 in	75 mm / 3 in
SolTub #4	508 mm / 20 in	320 mm / 12.6 in	128 mm / 5 in

## Rails and Cross Rails

### Series 05 Rails

The cross-beam or module carrying aluminum rails Eco05™, Solo05™, Profi05™ and ProfiPlus05™ are the most commonly used module carrying components of several different Schletter systems, especially in roof top applications. Each of the above mentioned rails has different characteristics with regard to its structural capabilities, such as span or load carrying ability. Please use the calculators provided in your client login at [www.secure.schletter.us](http://www.secure.schletter.us) or [www.secure.schletter.ca](http://www.secure.schletter.ca) to determine which rail will fit your specific application.



Eco05

Solo05



Profi05

ProfiPlus05



### S-Rail Series

The Rails in the S-Rail Series are named S0, S1, S1.5, S1.8, S2, S3, S3.5 and S4. These rails are commonly used as module carrying rails and are found mostly in the Schletter ground mounted systems (FS System™, PvMax™, Park@Sol™). Often these rails are combined with existing structures, such as carports, to accomplish large spans and integrate rail layers. Please ask a Schletter representative for specifics on structural aspects of the rails, such as span capabilities and load carrying capabilities.

### DN-Rail Series

The DN rail series is mostly used in roof top applications as an additional load distributing beam running below the “main” racking system, resulting in a layer system or cross-rail system. DN rails are categorized from DN0, DN1, DN2, DN2.5 and DN3. Each of the rails has a different span capability and load-bearing capability. Structural characteristics are available upon request. A large variety of other profile shapes are available to cover various spans, systems and loading conditions. Please ask your Schletter representative about structural characteristics and further information.

# FLAT ROOF

## Overview of Tilted Mounting Systems

With a wide variety of system components to choose from as well as roof types and orientations, analyzing the specific needs of each mounting project is necessary. The following describes different types of flat roof systems and system components that may be used in tilted mounting systems. Generally, two types of tilted mounting systems are available:

- a) Ballasted solutions (non-penetrating)
- b) Roof penetrating systems

**Ballasted** solutions should be used after a thorough examination performed on the basis of turbulent wind flow conditions and extensive wind-tunnel testing results. Schletter offers extensive design analysis using software adhering to the latest IBC code standards. It is not recommended to install a ballasted solution without verifying, with a structural engineer, the structure's ability to support the loading conditions imparted by the system. Additionally, PE stamped loading calculations will normally be required by building authorities.

A **penetrating system**, connected to a tilted mounting superstructure, follows the same roof material considerations as described in the previous sections, as well as attention to the roof orientation. A tilted system is, in general, built up of the following components:

- Ballast tub (ballast holding device) or a roof attachment for applications with penetrating systems
- Support triangle manufactured to the specified tilt of the system
- Cross beams to hold the modules
- Module clamps
- Wind deflector to reduce wind loads on rack

In the case of a penetrating system a distribution rail between the roof attachment and the support triangle may be needed in addition to meet spans for tie in points.

Tilted systems are usually designed by a Schletter representative to the specifications of the customer (tilt, lengths, modules stacked on top of each other, landscape or portrait orientation, wind and snow loads etc.). Please call a Schletter team member for more information or to request a design.

## Ballasted System Options

### FixGrid™

FixGrid is a non-penetrating ballasted system ideally suited for flat roofs the system combines versatility, material optimization, and speed of installation. Made of high quality aluminum FixGrid allows for modules in landscape orientation and tilt angles of 6 or 13 degrees. The system is ETL to UL 2703, certified to ULC/ORD Standard C1703, and has a fire resistance rating of Class A when used with Type I photovoltaic modules. Designs available for south-facing or east-west facing roof orientations.

➔ [FixGrid Product Sheet](#)

➔ [FixGrid Installation Manual](#)

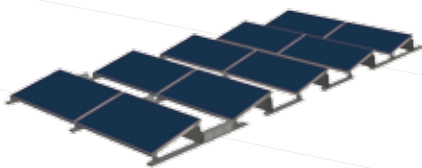

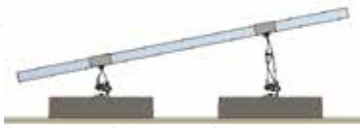
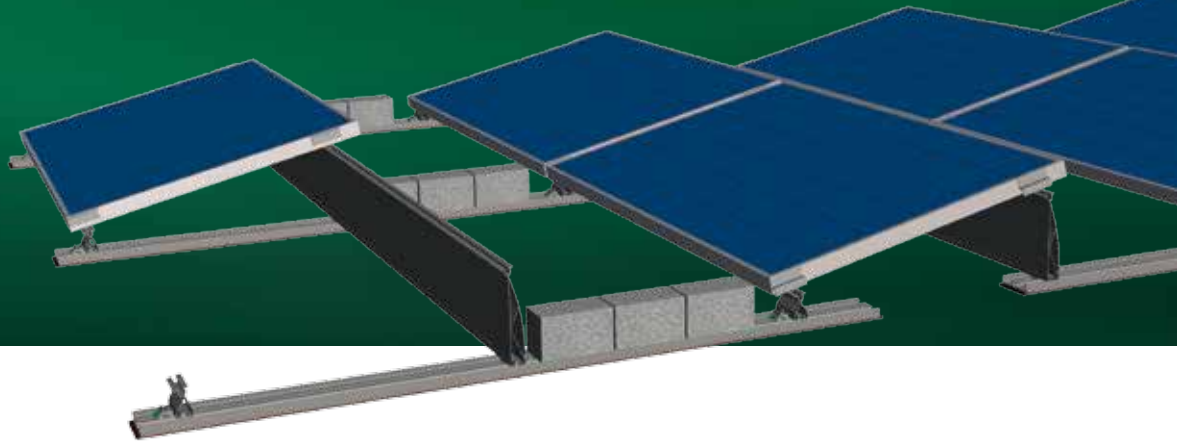

### Fix-EZ™

A custom designed Fix-EZ system from Schletter will come complete with our new proprietary ballast blocks which facilitate seamless attachment to the rest of the system structure. With minimal parts, serving multiple functions, Fix-EZ reduces cost and installation time without compromising system stability. This system is best suited for large commercial and utility scale installations and conforms to UL SUB 2703, is certified to ULC/ORD Std C1703. It has a fire rating of Class A when used with Type I or Type II modules in landscape orientation.

- ➔ [Fix-EZ Product Sheet](#)
- ➔ [Fix-EZ Installation Manual](#)

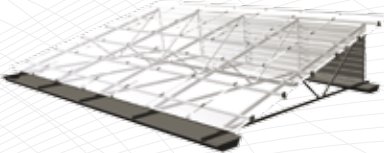

### Windsafe™, Ballasted

One of Schletter's original roof-mounted solar mounting systems, the Windsafe is a reliable, proven design made of durable triangle supports and can be attached to a ballast tray for flat roof applications or to roof-penetrating attachments. The ballasted option of Windsafe conforms to UL SUB 2703, is certified to ULC/ORD Std C1703. It has a fire rating of Class A when used with Type I modules in landscape orientation (only).

- ➔ [Windsafe Product Sheet](#)
- ➔ [Windsafe Ballasted Installation Manual](#)

## Penetrating System Designs

Schletter is known for creating safe, reliable solutions for solar PV installations that others might find too difficult. Often used in roof penetrating designs, most of these systems can be connected to clamping devices for a non-penetrating option. For more information please contact your Schletter team member.

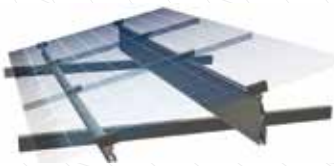

### FixZ Series™: FixZ-7 and FixZ-15

Comprised of the FixZ-7 and FixZ-15, this series attaches to a variety of roof attachments. With the FixZ-7 additional module tilts of 5 to 7 degrees are possible while the FixZ-15 provides 12 to 15 degrees, depending on the module size.

- ➔ [FixZ-7 Product Sheet](#)
- ➔ [FixZ-15 Product Sheet](#)

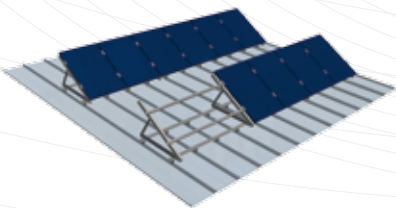

### CompactGrid™

For flat or low-pitched roofs, the CompactGrid is designed for roof orientations facing east/west. This system is specifically designed to distribute load evenly while spanning large distances between purlins and is able to connect to a variety of roof types/materials. Roof cladding must be able to safely absorb occurring wind loads and transfer them to substructure.

- ➔ [CompactGrid Product Sheet](#)

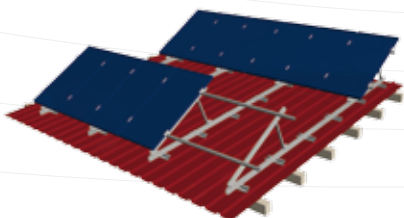

### CompactVario™

Used for both flat and low-pitched roofs, the CompactVario offers a highly flexible design spanning large distances between purlins (rails). The CompactVario can be designed for non-penetrating or penetrating roofs making it mountable to almost any purlin roof structure. Custom cut to allow for quick on-site assembly, no cutting or drilling required by the installer. Distribution rail usually runs North-South while crossing east-West running trusses (or purlins) of the roof.

- ➔ [CompactVario Product Sheet](#)

# FACADE & AWNINGS

## Facade Systems

Mounting to a facade involves fastening panels to vertical walls and often this is accomplished through standard Schletter components for unframed or laminated modules. Facades are comprised of:

1. Anchor brackets for wall mounting
2. Module bearing rail
3. Module clamps

Please contact a Schletter team member for questions regarding facade solar mounting systems.

## Awning Systems

The awning system is a specially designed facade mount. Awning supports (also called facade supports) are mounted to vertical walls or facades, and bear the rails for the module rows.

Facade and awnings systems are available in three options:

1. for stand-alone installations larger than 50 kW,
2. as an add-on product in combination with other Schletter solar mounting systems,
3. or as a kit (awning only) on Schletter's ecommerce site (Schletter does not provide engineering for online awning kits).



# ACCESSORIES



## System Grounding

Meeting the demands of the latest Industry Standards, Schletter releases the new **Rapid5k™** module clamp. Based on the proven history of the Rapid2+ and featuring a more robust grounding element, the Rapid5k meets the toughest UL 2703 industry standards while reducing costs.

➔ [System-Specific Installation Manuals](#)



## Fire Safety

California has passed fire safety laws for roof-mounted solar installations. In order to meet this states fire safety regulations, Schletter has undergone testing with key roof mount systems including Standard Flush Mount, Windsafe, Fix-EZ, and FixGrid. For more information on each fire safety rating, please see the corresponding installation manual, available online.

➔ [System-Specific Installation Manuals](#)

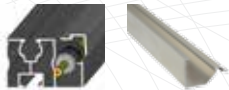

Profi profile with cable duct cover for other Series 05 rails

## Cable Management Options

Clean and professional cable routing can have an influence on the end-user's overall impression of the solar mounting quality and installation technique. Schletter offers several options for cable management including a cable duct with cover as seen in Schletter's Profi rails, and snap-in-place options for the Series 05 rails.

If extensive wiring is required, we offer the cable duct system MaxK™. Different system components and even an extendable universal duct are available. In cases in which a cable duct would be undesirable or when additional cables have to be fixed, ProKlips™ can be inserted in the Klick™ grooves of the rails.

➔ [Cable Management Product Sheet](#)



Rectangular cable duct ProKlip-S

## SecuFix™

SecuFix is a simple anti-theft device that can be combined with all new Schletter systems or retrofitted to an existing Schletter system. The socket head screws of the module clamps are secured against any unauthorized loosening by a high-grade stainless steel ball which is punched into the screw head.

➔ [Components Overview Brochure](#)



SecuFix-applicator

## Schletter Inc.

www.schletter.us  
mail@schletter.us  
(888) 608 - 0234



### North American Headquarters Manufacturing and Sales

1001 Commerce Center Drive  
Shelby, North Carolina 28150 USA  
Tel: (704) 595 - 4200  
Fax: (704) 595 - 4210



### Distribution, Sales, and Training

2201 N Forbes Blvd  
Tucson, Arizona 85745 USA  
Tel: (520) 289 - 8700  
Fax: (520) 289 - 8696

## Schletter Canada, Inc.

www.schletter.ca  
mail@schletter.ca



### Ontario Manufacturing and Sales

3181 Devon Drive  
Windsor, Ontario N8X 4L3 Canada  
Tel: (519) 946 - 3800  
Fax: (519) 946 - 3805

### Connect On-line

 [facebook.com/schletterinc](https://facebook.com/schletterinc)  
 [twitter.com/schletterinc](https://twitter.com/schletterinc)  
 [youtube.com/schletterinc](https://youtube.com/schletterinc)

### Event/Workshop Information

Phone: (520) 289 - 8725  
Fax: (520) 289 - 8696  
E-mail: [marketing@schletter.us](mailto:marketing@schletter.us)

